

Compact cylinder—SDA Series

Compendium of SDA Series

Manufactured by our enterprise

Magnetic switch slots around the cylinder body
There are magnetic switch slots around the cylinder body convenient to install inducting switch.

Two kinds of rod type

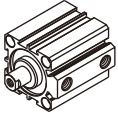

Female thread

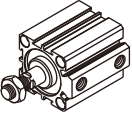







Male thread

Ten bore size are available
Bore size: 12, 16, 20, 25, 32, 40, 50, 63, 80, 100

Compact structure
Riveted structure is adopted to connect the cylinder body and back cover, and piston and piston rod to make it compact and reliable

Multi-type cylinder

SDA: Compact cylinder (Double acting)	
SSA: Compact cylinder (Single acting-push)	
STA: Compact cylinder (Single acting-pull)	
SDAD: Compact cylinder (Double rod)	
SDAJ: Compact cylinder (Adjustable stroke)	
SDAT: Compact cylinder (Duplex type)	
SDAW: Compact cylinder (Duplex-end type)	

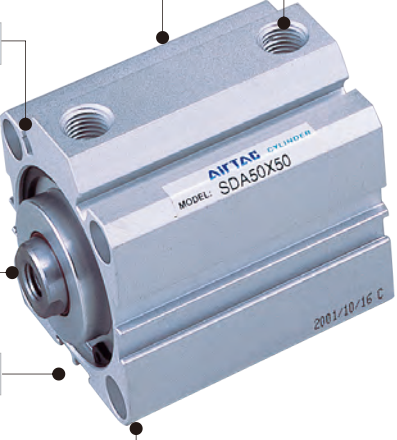

Criteria for selection: Cylinder thrust

Unit : Newton(N)

Bore size	Rod size	Acting type	Pressure area(mm ²)	Operating pressure(MPa)							Bore size	Rod size	Acting type	Pressure area(mm ²)	Operating pressure(MPa)								
				0.1	0.2	0.3	0.4	0.5	0.6	0.7					0.1	0.2	0.3	0.4	0.5	0.6	0.7		
12	6	Single acting	Push side	113.1	-	12.6	23.9	35.2	46.5	57.9	69.2	40	16	Single acting	Push side	1256.6	-	168.6	294.3	420.0	545.6	671.3	796.9
			Pull side	84.8	-	7.0	15.4	23.9	32.4	40.9	49.4				1055.6	-	128.4	234.0	339.5	445.1	550.6	656.2	
		Double acting	Push side	113.1	-	22.6	33.9	45.2	56.5	67.9	79.2			1256.6	125.7	251.3	377.0	502.7	628.3	754.0	879.6		
			Pull side	84.8	-	17.0	25.4	33.9	42.4	50.9	59.4			1055.6	105.6	211.1	316.7	422.2	527.8	633.3	738.9		
16	6	Single acting	Push side	201.1	-	20.2	40.3	60.4	80.5	100.6	120.7	50	20	Single acting	Push side	1963.5	89.3	285.7	482.0	678.4	874.7	1071.1	1267.4
			Pull side	172.8	-	14.6	31.8	49.1	66.4	83.7	101.0				1649.3	57.9	222.9	387.8	552.7	717.7	882.6	1047.5	
		Double acting	Push side	201.1	-	40.2	60.3	80.4	100.5	120.6	140.7			1963.5	196.3	392.7	589.0	785.4	981.7	1178.1	1374.4		
			Pull side	172.8	-	34.6	51.8	69.1	86.4	103.7	121.0			1649.3	164.9	329.9	494.8	659.7	824.7	989.6	1154.5		
20	8	Single acting	Push side	314.2	-	39.8	71.2	102.7	134.1	165.5	196.9	63	20	Single acting	Push side	3117.2	135.7	447.4	759.2	1070.9	1382.6	1694.3	2006.1
			Pull side	263.9	-	29.8	56.2	82.6	108.9	135.3	161.7				2803.1	104.3	384.6	664.9	945.2	1225.5	1505.9	1786.2	
		Double acting	Push side	314.2	-	62.8	94.2	125.7	157.1	188.5	219.9			3117.2	311.7	623.4	935.2	1246.9	1558.6	1870.3	2182.1		
			Pull side	263.9	-	52.8	79.2	105.6	131.9	158.3	184.7			2803.1	280.3	560.6	840.9	1121.2	1401.5	1681.9	1962.2		
25	10	Single acting	Push side	490.9	-	69.7	118.8	167.8	216.9	266.0	315.1	80	25	Double acting	Push side	5026.5	502.7	1005.3	1508.0	2010.6	2513.3	3015.9	3518.6
			Pull side	412.3	-	54.0	95.2	136.4	177.7	218.9	260.1				4535.7	453.6	907.1	1360.7	1814.3	2267.8	2721.4	3175.0	
		Double acting	Push side	490.9	-	98.2	147.3	196.3	245.4	294.5	343.6			7854.0	785.4	1570.8	2356.2	3141.6	3927.0	4712.4	5497.8		
			Pull side	412.3	-	82.5	123.7	164.9	206.2	247.4	288.6			7049.7	705.0	1409.9	2114.9	2819.9	3524.9	4229.8	4934.8		
32	12	Single acting	Push side	804.2	-	105.3	185.8	266.2	346.6	427.0	507.5	100	32	Double acting	Push side	7854.0	785.4	1570.8	2356.2	3141.6	3927.0	4712.4	5497.8
			Pull side	691.2	-	82.7	151.8	221.0	290.1	359.2	428.3				7049.7	705.0	1409.9	2114.9	2819.9	3524.9	4229.8	4934.8	
		Double acting	Push side	804.2	-	160.8	241.3	321.7	402.1	482.5	563.0												
			Pull side	691.2	-	138.2	207.3	276.5	345.6	414.7	483.8												

Installation and application



1. When load changes in the work, the cylinder with abundant output capacity shall be selected.
2. Relative cylinder with high temperature resistance or corrosion resistance shall be chosen under the condition of high temperature or corrosion.
3. Necessary protection measure shall be taken in the environment with higher humidity, much dust or water drops, oil dust and welding dregs.
4. Dirty substances in the pipe must be eliminated before cylinder is connected with pipeline to prevent the entrance of particles into the cylinder.
5. The medium used by cylinder shall be filtered to 40μm or below.
6. As both of the front cover and piston of the cylinder are short, typically too large stroke can not be selected.
7. Anti-freezing measure shall be adopted under low temperature environment to prevent moisture freezing.
8. The cylinder shall avoid the influence of side load in operation to maintain the normal work of cylinder and extend the service life.
9. If the cylinder is dismantled and stored for a long time, please conduct anti-rust treatment to the surface. Anti-dust caps shall be added in air inlet and outlet ports. The front and back cover can not be dismantled, which shall be especially noticed.

Compact cylinder

SDA Series

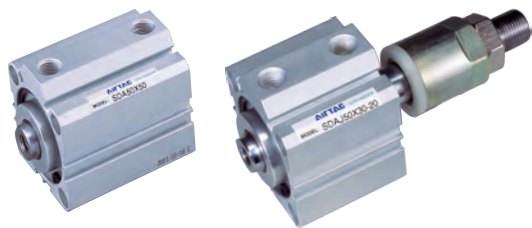

Specification

Bore size(mm)		12	16	20	25	32	40	50	63	80	100
Acting type		Double acting									
		Single acting_Push type、Single acting_Pull type									
Fluid		Air(to be filtered by 40μm filter element)									
Operating pressure	Double acting	0.15~1.0MPa(22~145psi)(1.5~10.0bar)									
	Single acting	0.2~1.0MPa(28~145psi)(2.0~10.0bar)									
Proof pressure		1.5MPa(215psi)(15bar)									
Temperature °C		-20~70									
Speed range mm/s		Double acting : 30~500 Single acting : 50~500									
Stroke tolerance		Strokes≤100 $^{+1.0}_0$ Stroke>100 $^{+1.5}_0$									
Cushion type		Bumper									
Port size [Note1]		M5×0.8			1/8"		1/4"		3/8"		

[Note1] PT thread is available.
Add) Refer to P365 for detail of sensor switch.

Symbol

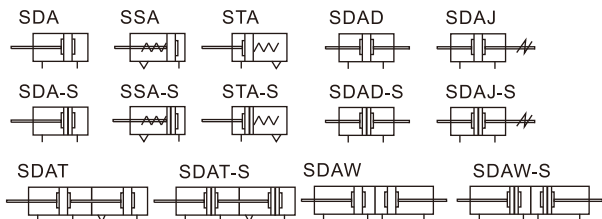

Stroke

Bore size (mm)		Standard stroke (mm)										Max.std stroke													
12	Double acting	With magnet	5	10	15	20	25	30	35	40	45	50	50												
		Without magnet	5	10	15	20	25	30	35	40	45	50	55	60	60										
16	Single acting	5 10 15 20 25 30										30													
		Double acting	5	10	15	20	25	30	35	40	45	50	55	60	65	70	75	80	85	90	90				
20	Double acting	With magnet	5	10	15	20	25	30	35	40	45	50	55	60	65	70	75	80	85	90	100	100			
		Without magnet	5	10	15	20	25	30	35	40	45	50	55	60	65	70	75	80	85	90	100	100			
25	Single acting	5 10 15 20 25 30										30													
		Double acting	With magnet	5	10	15	20	25	30	35	40	45	50	55	60	65	70	75	80	85	90	100	110	120	120
40	Double acting		Without magnet	5	10	15	20	25	30	35	40	45	50	55	60	65	70	75	80	85	90	100	110	120	130
		50	Single acting	5 10 15 20 25 30										30											
63	Double acting			With magnet	5	10	15	20	25	30	30														
		80	Double acting	Without magnet	5	10	15	20	25	30	35	40	45	50	55	60	65	70	75	80	85	90	100	110	120
100	Double acting			Without magnet	5	10	15	20	25	30	35	40	45	50	55	60	65	70	75	80	85	90	100	110	120

Note) 1. Please contact the company for other special strokes.
2. The dimensions of non-std stroke cylinder has the same dimensions as the next longer stroke std. stroke cylinder. e.g. 23mm stroke cylinder has the same dimensions of 25 std. stroke cylinder.

Product feature

1. Manufactured by our enterprise.
2. Riveted structure is adopted to connect the cylinder body and back cover, and piston and piston rod to make it compact and reliable;
3. The inner diameter of the body is treated with rolling followed by the treatment of hard anodizing, forming an excellent abrasion resistance and durability.
4. The seal of piston adopts heterogeneous two-way seal structure. It has compact dimension and the function of grease reservation.
5. Compact structure can effectively save installation space.
6. There are magnetic switch slots around the cylinder body, which is convenient to install sensor switch
7. Mounting accessories with various specifications are optional.

Ordering code

SDA 20 × 30 S B □

SDAD 20 × 30 S B □

SDAJ 20 × 30-30 S B □

① ② ③ ④ ⑤ ⑥ ⑦

① Model	② Bore size	③ Stroke	④ Adjustable Stroke	⑤ Magnet	⑥ Rod type	⑦ Thread type [Note1]
SDA: Compact cylinder(Double acting)	12 16 20 25 32 40 50 63 80 100	Refer to stroke table for details	No this code	Blank: Without magnet S: With magnet	Blank: Female thread B: Male thread	Blank: PT
SSA: Compact cylinder(Single acting-push)	12 16 20 25 32 40 50 63					
STA: Compact cylinder(Single acting-pull)						
SDAD: Compact cylinder(Double rod)	12 16 20 25 32 40 50 63 80 100		10 20 30 40 50 75 100			
SDAJ: Compact cylinder(Adjustable stroke)						

SDAT 20 × 30 × 10 S B □

① ② ③ ④ ⑤ ⑥ ⑦

① Model	② Bore size	③ Stroke 1	④ Stroke 2 [Note2]	⑤ Magnet	⑥ Rod type	⑦ Thread type [Note1]
SDAT: Compact cylinder (Duplex type)	12 16 20 25 32 40 50 63 80 100	Refer to stroke table for details	Refer to stroke table for details	Blank: Without magnet S: With magnet	Blank: Female thread B: Male thread	Blank: PT
SDAW: Compact cylinder(Duplex-end type)						

[Note1] Standard thread is blank here.

[Note2] Stroke1+Stroke2≤The value in the stroke table.

Compact cylinder

SDA Series

Inner structure and material of major parts

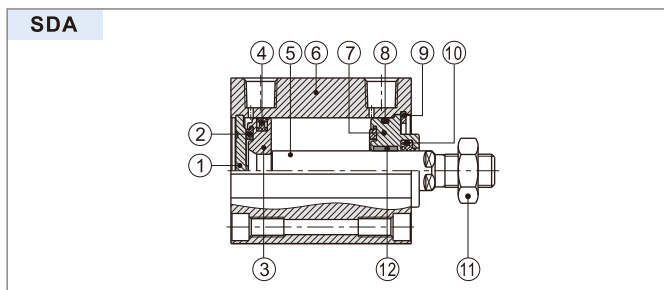

NO.	Item	Material
1	Back cover	No(Φ12, 16)/Aluminum alloy(Others)
2	Bumper	NBR
3	Piston	Brass(Φ12, 16)/Aluminum alloy(Others)
4	Piston seal	NBR
5	Piston rod	Carbon steel with 20μm chrome plated
6	Body	Aluminum alloy
7	Front cover	Aluminum alloy
8	O-ring	NBR
9	C clip	Spring steel
10	Front cover packing	NBR
11	Piston nut	Carbon steel
12	Bushing	No(Φ12~32)/Wear resistant material(Others)

Dimensions

SDA

Φ12, Φ16

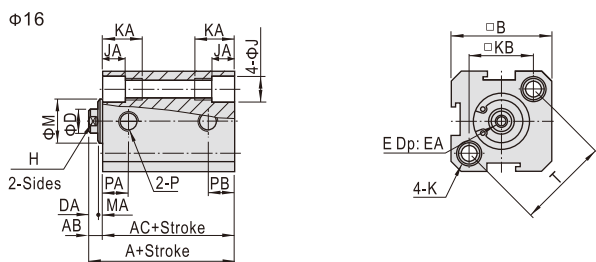

Φ20~Φ100

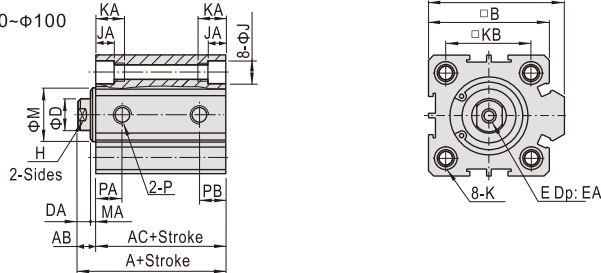

Item	A		AC		AB	B	BA	D	DA	E	EA	H	J	JA	K	KA	KB	M	MA	P	PA		PB		T
	Without magnet	With magnet	Without magnet	With magnet																	St=5	St>5	St=5	St>5	
12	22	17	32	27	5	25	-	6	4	M3×0.5	6	5	6.5	4.5	M5×0.8Thru.hole:Φ4.2	12	16.3	10.2	1	M5×0.8	7.5	7.5	5	5	23
16	24	18.5	34	28.5	5.5	29	-	6	4	M3×0.5	6	5	6.5	4.5	M5×0.8Thru.hole:Φ4.2	12	19.8	11	1.5	M5×0.8	8	8	5	5.5	28
20	25	19.5	35	29.5	5.5	34	36	8	4	M4×0.7	8	6	6.5	4.5	M5×0.8Thru.hole:Φ4.2	14	24	13	1.5	M5×0.8	8	9	5	5.5	-
25	27	21	37	31	6	40	42	10	4	M5×0.8	10	8	8.2	5.5	M6×1.0Thru.hole:Φ5.2	15	28	17	2	M5×0.8	9	9	5.5	5.5	-
32	31.5	24.5	41.5	34.5	7	44	50	12	4.5	M6×1.0	12	10	8.2	5.5	M6×1.0Thru.hole:Φ5.2	16	34	22	2.5	1/8"	9	9	6.5	9	-
40	33	26	43	36	7	52	58.5	16	4	M8×1.25	12	14	10.5	6.5	M8×1.25Thru.hole:Φ6.7	20	40	28	3	1/8"	9.5	9.5	7.5	7.5	-
50	37	28	47	38	9	62	71.5	20	5	M10×1.5	15	17	10.5	6.5	M8×1.25Thru.hole:Φ6.7	25	48	38	4	1/4"	8	10.5	8	10.5	-
63	41	32	51	42	9	75	84.5	20	5	M10×1.5	15	17	10.5	6.5	M8×1.25Thru.hole:Φ6.7	25	60	40	4	1/4"	9.5	12	9.5	11	-
80	52	41	62	51	11	94	104	25	6	M14×1.5	20	22	17	11	M12×1.75Thru.hole:Φ10.4	25	74	45	5	3/8"	11.5	14.5	11.5	14.5	-
100	63	51	73	61	12	114	124	32	7	M18×1.5	20	27	19	13	M14×2.0Thru.hole:Φ12.4	30	90	55	5	3/8"	16	20.5	16	20.5	-

Male thread

Φ12, Φ16

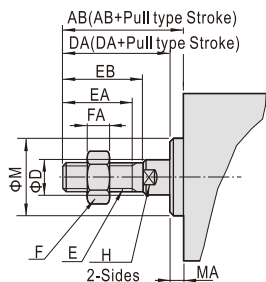

Φ20~Φ100

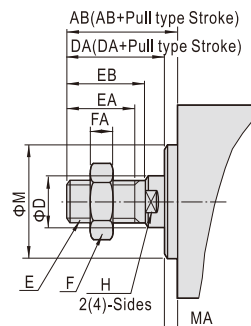

Bore size/Item	AB	D	DA	E	EA	EB	F	FA	H	M	MA	
											SDAD\SDAJ	Others
12	17	6	16	M5×0.8	10	12	8	4	5	10.2	1	1
16	17.5	6	16	M5×0.8	10	12	8	4	5	11	1.5	1.5
20	20.5	8	19	M6×1.0	13	15	10	5	6	13	1.5	1.5
25	23	10	21	M8×1.25	15	17	12	6	8	17	2	2
32	25	12	22	M10×1.25	15	18	17	6	10	22	3	2.5
40	35	16	32	M14×1.5	25	27.5	19	8	14	28	3	3
50	36.5	20	32.5	M18×1.5	25.5	27.5	27	11	17	38	4	4
63	37.5	20	33.5	M18×1.5	26	28	27	11	17	40	4	4
80	44	25	39	M22×1.5	30	33	32	13	22	45	5	5
100	50	32	45	M26×1.5	35	38	36	13	27	55	5	5

Compact cylinder

SDA Series

SSA

φ12, φ16

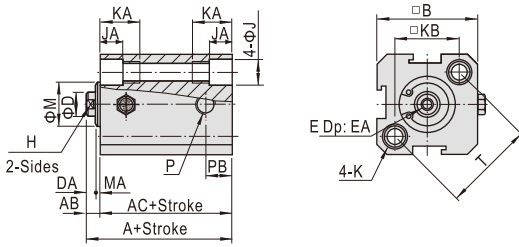

STA

φ12, φ16

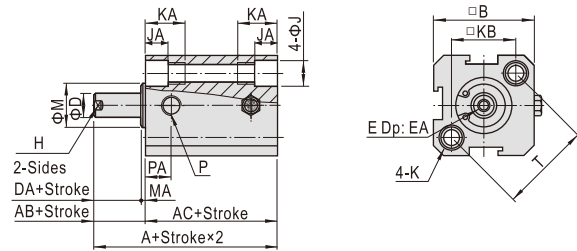

φ20-φ63

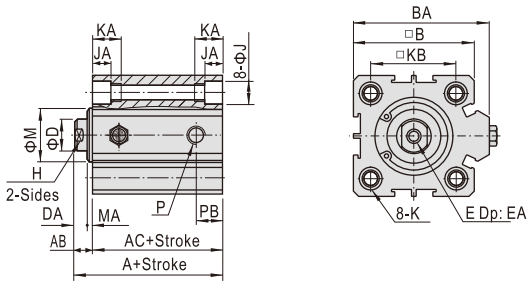

φ20-φ63

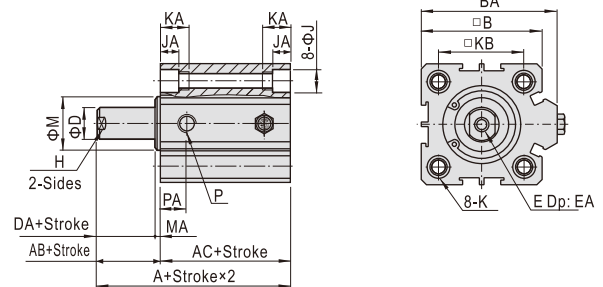

Bore size\Item	A(Without magnet)		A(With magnet)		AB	AC(Without magnet)		AC(With magnet)		B	BA
	St≤10	St>10	St≤10	St>10		St≤10	St>10	St≤10	St>10		
12	32	42	42	52	5	27	37	37	47	25	-
16	34	44	44	54	5.5	28.5	38.5	38.5	48.5	29	-
20	35	45	45	55	5.5	29.5	39.5	39.5	49.5	34	36
25	37	47	47	57	6	31	41	41	51	40	42
32	41.5	51.5	51.5	61.5	7	34.5	44.5	44.5	54.5	44	50
40	43	53	53	63	7	36	46	46	56	52	58.5
50	47	57	57	67	9	38	48	48	58	62	71.5
63	51	61	61	71	9	42	52	52	62	75	84.5

Bore size\Item	D	DA	E	EA	H	J	JA	K				KA	KB	M	MA	P	PA	PB	T
								M5×0.8 Thru.hole:Φ4.2	M5×0.8 Thru.hole:Φ4.2	M6×1.0 Thru.hole:Φ5.2	M6×1.0 Thru.hole:Φ5.2								
12	6	4	M3×0.5	6	5	6.5	4.5	M5×0.8 Thru.hole:Φ4.2	12	16.3	10.2	1	M5×0.8	7.5	5	23			
16	6	4	M3×0.5	6	5	6.5	4.5	M5×0.8 Thru.hole:Φ4.2	12	19.8	11	1.5	M5×0.8	8	5.5	28			
20	8	4	M4×0.7	8	6	6.5	4.5	M5×0.8 Thru.hole:Φ4.2	14	24	13	1.5	M5×0.8	9	5.5	-			
25	10	4	M5×0.8	10	8	8.2	5.5	M6×1.0 Thru.hole:Φ5.2	15	28	17	2	M5×0.8	9	5.5	-			
32	12	4	M6×1.0	12	10	8.2	5.5	M6×1.0 Thru.hole:Φ5.2	16	34	22	2.4	1/8"	9	9	-			
40	16	4	M8×1.25	12	14	10.5	6.5	M8×1.25 Thru.hole:Φ6.7	20	40	28	3	1/8"	9.5	7.5	-			
50	20	5	M10×1.5	15	17	10.5	6.5	M8×1.25 Thru.hole:Φ6.7	25	48	38	4	1/4"	10.5	10.5	-			
63	20	5	M10×1.5	15	17	10.5	6.5	M8×1.25 Thru.hole:Φ6.7	25	60	40	4	1/4"	12	11	-			

Note) Please refer to Page 132 for the dimension of male thread.

Compact cylinder

SDA Series

SDAD

Φ12、Φ16

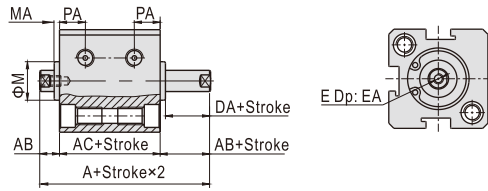

Φ20~Φ100

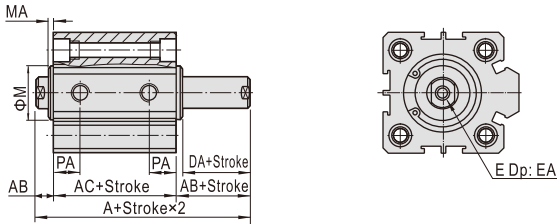

Bore size/Item	A	AC	A	AC	AB	DA
	Without magnet		With magnet			
12	27	17	37	27	5	4
16	29.5	18.5	39.5	28.5	5.5	4
20	30.5	19.5	40.5	29.5	5.5	4
25	33	21	43	31	6	4
32	38.5	24.5	48.5	34.5	7	4
40	40	26	50	36	7	4
50	46	28	56	38	9	5
63	50	32	60	42	9	5
80	63	41	73	51	11	6
100	75	51	85	61	12	7

Bore size/Item	E	EA		M	MA		PA	
		St≤10	St>10		St=5	St>5	R	
12	M3×0.5	6	6	10.2	1	5.5		6.3
16	M3×0.5	6	6	11	1.5	6.5	7.3	M5×0.8
20	M4×0.7	8(6.5 for St=5)		15	1.5	7.5	7.5	M6×1.0
25	M5×0.8	10(7 for St=5)		17	2	8	8	M8×1.25
32	M6×1.0	8	12	22	3	8	9	M10×1.25
40	M8×1.25	8	12	28	3	8	10	M12×1.25
50	M10×1.5	8	15	38	4	8	10.5	M16×1.5
63	M10×1.5	10	15	40	4	9.5	11.8	M16×1.5
80	M14×1.5	13	20	45	5	11.5	14.5	M20×1.5
100	M18×1.5	18	20	55	5	16	20.5	M27×2.0

Note) The unmarked dimension is the same as SDA standard type.
Please refer to Page 132 for the dimension of male thread.

SDAJ

Φ12、Φ16

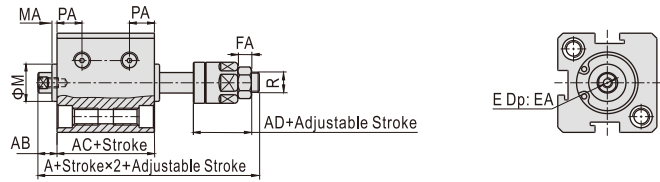

Φ20~Φ100

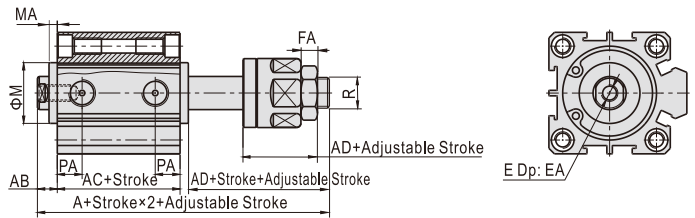

Bore size/Item	A	AC	A	AC	AB	AD	E
	Without magnet		With magnet				
12	40	17	50	27	5	17	M3×0.5
16	42.5	18.5	52.5	28.5	5.5	17	M3×0.5
20	47.5	19.5	57.5	29.5	5.5	21	M4×0.7
25	54	21	64	31	6	25	M5×0.8
32	61.5	24.5	71.5	34.5	7	27	M6×1.0
40	64	26	74	36	7	28	M8×1.25
50	70	28	80	38	9	29	M10×1.5
63	74	32	84	42	9	29	M10×1.5
80	92.5	41	102.5	51	11	35.5	M14×1.5
100	110.5	51	120.5	61	12	42.5	M18×1.5

Bore size/Item	EA		FA	M	MA		PA		R
	St≤10	St>10			St=5	St>5			
12	6	6	4	10.2	1	5.5	6.3	M5×0.8	
16	6	6	4	11	1.5	6.5	7.3	M5×0.8	
20	8(6.5 for St=5)		5	15	1.5	7.5	7.5	M6×1.0	
25	10(7 for St=5)		6	17	2	8	8	M8×1.25	
32	8	12	6	22	3	8	9	M10×1.25	
40	8	12	7	28	3	8	10	M12×1.25	
50	8	15	8	38	4	8	10.5	M16×1.5	
63	10	15	8	40	4	9.5	11.8	M16×1.5	
80	13	20	10	45	5	11.5	14.5	M20×1.5	
100	18	20	13.5	55	5	16	20.5	M27×2.0	

Note) The unmarked dimension is the same as SDA standard type.
Please refer to Page 132 for the dimension of male thread.

Compact cylinder

SDA Series

SDAT

φ12、φ16

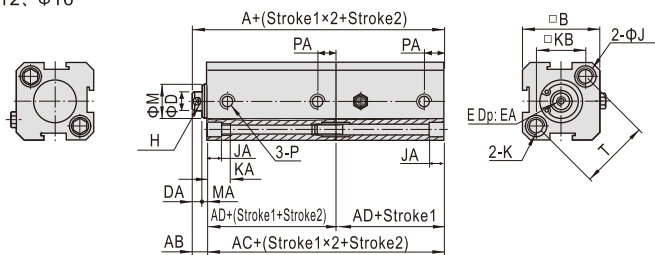

SDAW

φ12、φ16

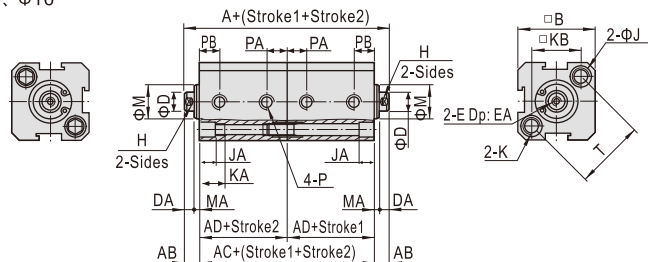

φ20~φ100

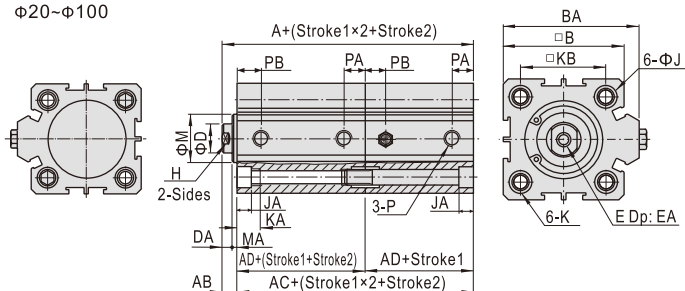

φ20~φ100

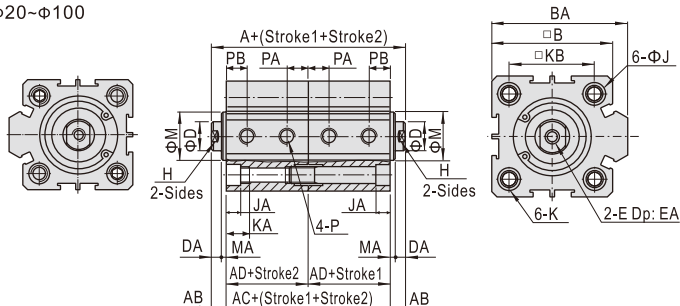

Note) Please refer to Page 132 for the dimension of male thread.

Bore size\Item	Without magnet			With magnet			AB	B	BA	D	DA
	A	AC	AD	A	AC	AD					
12	39	34	17	59	54	27	5	25	-	6	4
16	42.5	37	18.5	62.5	57	28.5	5.5	29	-	6	4
20	44.5	39	19.5	64.5	59	29.5	5.5	34	36	8	4
25	48	42	21	68	62	31	6	40	42	10	4
32	56	49	24.5	76	69	34.5	7	44	50	12	4
40	59	52	26	79	72	36	7	52	58.5	16	4
50	65	56	28	85	76	38	9	62	71.5	20	5
63	73	64	32	93	84	42	9	75	84.5	20	5
80	93	82	41	113	102	51	11	94	104	25	6
100	114	102	51	134	122	61	12	114	124	32	7

Bore size\Item	E	EA	H	J	JA	K		KA
						M5×0.8 Thru.hole:Φ4.2	M6×1.0 Thru.hole:Φ5.2	
12	M3×0.5	6	5	6.5	4.5	M5×0.8 Thru.hole:Φ4.2	12	12
16	M3×0.5	6	5	6.5	4.5	M5×0.8 Thru.hole:Φ4.2	12	12
20	M4×0.7	8	6	6.5	4.5	M5×0.8 Thru.hole:Φ4.2	14	14
25	M5×0.8	10	8	8.2	5.5	M6×1.0 Thru.hole:Φ5.2	15	15
32	M6×1.0	12	10	8.2	5.5	M6×1.0 Thru.hole:Φ5.2	16	16
40	M8×1.25	12	14	10.5	6.5	M8×1.25 Thru.hole:Φ6.7	20	20
50	M10×1.5	15	17	10.5	6.5	M8×1.25 Thru.hole:Φ6.7	25	25
63	M10×1.5	15	17	10.5	6.5	M8×1.25 Thru.hole:Φ6.7	25	25
80	M14×1.5	20	22	17	11	M12×1.75 Thru.hole:Φ10.4	25	25
100	M18×1.5	20	27	19	13	M14×2.0 Thru.hole:Φ12.4	30	30

Bore size\Item	KB	M	MA	P	PA		PB	
					St=5	St>5	St=5	St>5
12	16.3	10.2	1	M5×0.8	5	5	7.5	7.5
16	19.8	11	1.5	M5×0.8	5.5	5.5	8	8
20	24	13	1.5	M5×0.8	5	5.5	8	9
25	28	17	2	M5×0.8	5.5	5.5	9	9
32	34	22	2.5	1/8"	6.5	9	9	9
40	40	28	3	1/8"	7.5	7.5	9.5	9.5
50	48	38	4	1/4"	8	10.5	8	10.5
63	60	40	4	1/4"	9.5	11	9.5	12
80	74	45	5	3/8"	11.5	14.5	11.5	14.5
100	90	55	5	3/8"	16	20.5	16	20.5

Note) Please refer to Page 132 for the dimension of male thread.

Bore size\Item	Without magnet			With magnet			AB	B	BA	D	DA
	A	AC	AD	A	AC	AD					
12	44	34	17	64	54	27	5	25	-	6	4
16	48	37	18.5	68	57	28.5	5.5	29	-	6	4
20	50	39	19.5	70	59	29.5	5.5	34	36	8	4
25	54	42	21	74	62	31	6	40	42	10	4
32	63	49	24.5	83	69	34.5	7	44	50	12	4
40	66	52	26	86	72	36	7	52	58.5	16	4
50	74	56	28	94	76	38	9	62	71.5	20	5
63	82	64	32	102	84	42	9	75	84.5	20	5
80	104	82	41	124	102	51	11	94	104	25	6
100	126	102	51	146	122	61	12	114	124	32	7

Bore size\Item	E	EA	H	J	JA	K		KA
						M5×0.8 Thru.hole:Φ4.2	M6×1.0 Thru.hole:Φ5.2	
12	M3×0.5	6	5	6.5	4.5	M5×0.8 Thru.hole:Φ4.2	12	12
16	M3×0.5	6	5	6.5	4.5	M5×0.8 Thru.hole:Φ4.2	12	12
20	M4×0.7	8	6	6.5	4.5	M5×0.8 Thru.hole:Φ4.2	14	14
25	M5×0.8	10	8	8.2	5.5	M6×1.0 Thru.hole:Φ5.2	15	15
32	M6×1.0	12	10	8.2	5.5	M6×1.0 Thru.hole:Φ5.2	16	16
40	M8×1.25	12	14	10.5	6.5	M8×1.25 Thru.hole:Φ6.7	20	20
50	M10×1.5	15	17	10.5	6.5	M8×1.25 Thru.hole:Φ6.7	25	25
63	M10×1.5	15	17	10.5	6.5	M8×1.25 Thru.hole:Φ6.7	25	25
80	M14×1.5	20	22	17	11	M12×1.75 Thru.hole:Φ10.4	25	25
100	M18×1.5	20	27	19	13	M14×2.0 Thru.hole:Φ12.4	30	30

Bore size\Item	KB	M	MA	P	PA		PB	
					St=5	St>5	St=5	St>5
12	16.3	10.2	1	M5×0.8	5	5	7.5	7.5
16	19.8	11	1.5	M5×0.8	5	5.5	8	8
20	24	13	1.5	M5×0.8	5	5.5	8	9
25	28	17	2	M5×0.8	5.5	5.5	9	9
32	34	22	2.5	1/8"	6.5	9	9	9
40	40	28	3	1/8"	7.5	7.5	9.5	9.5
50	48	38	4	1/4"	8	10.5	8	10.5
63	60	40	4	1/4"	9.5	11	9.5	12
80	74	45	5	3/8"	11.5	14.5	11.5	14.5
100	90	55	5	3/8"	16	20.5	16	20.5